

H180xW185

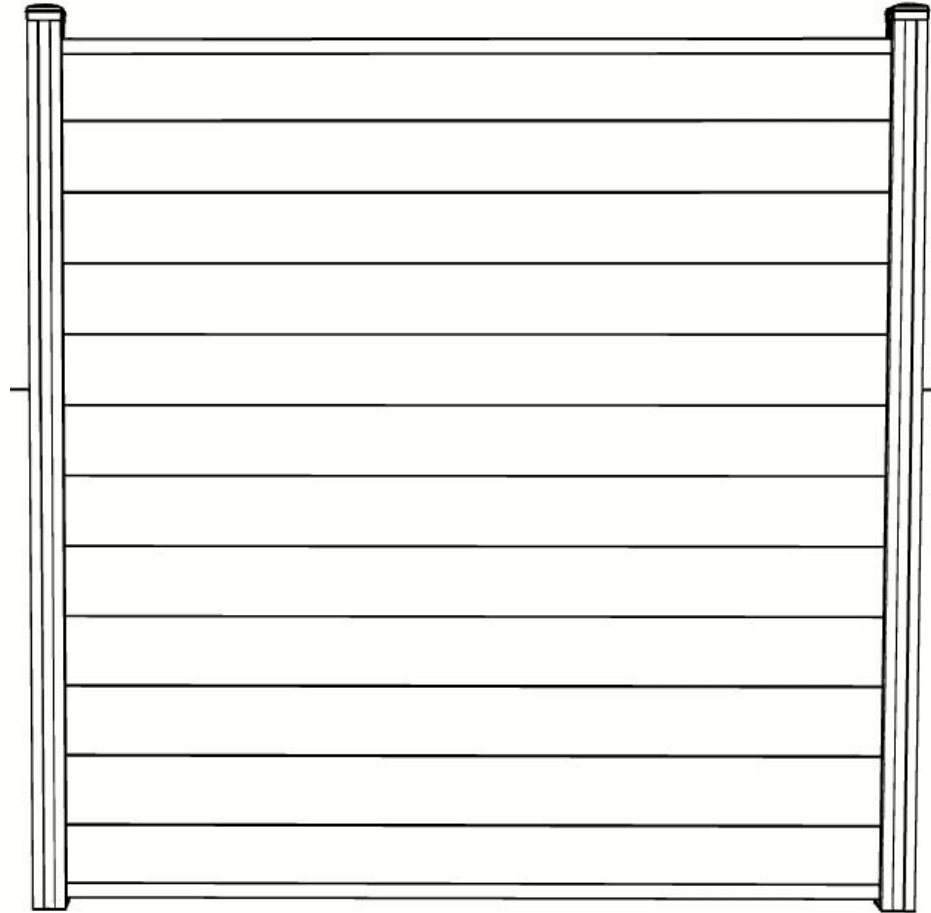

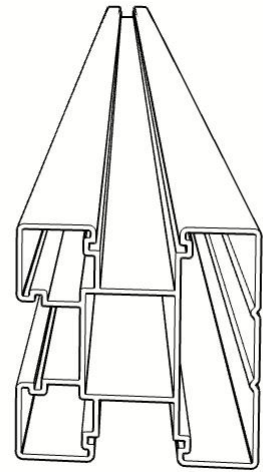

1 2.7m Aluminum Post

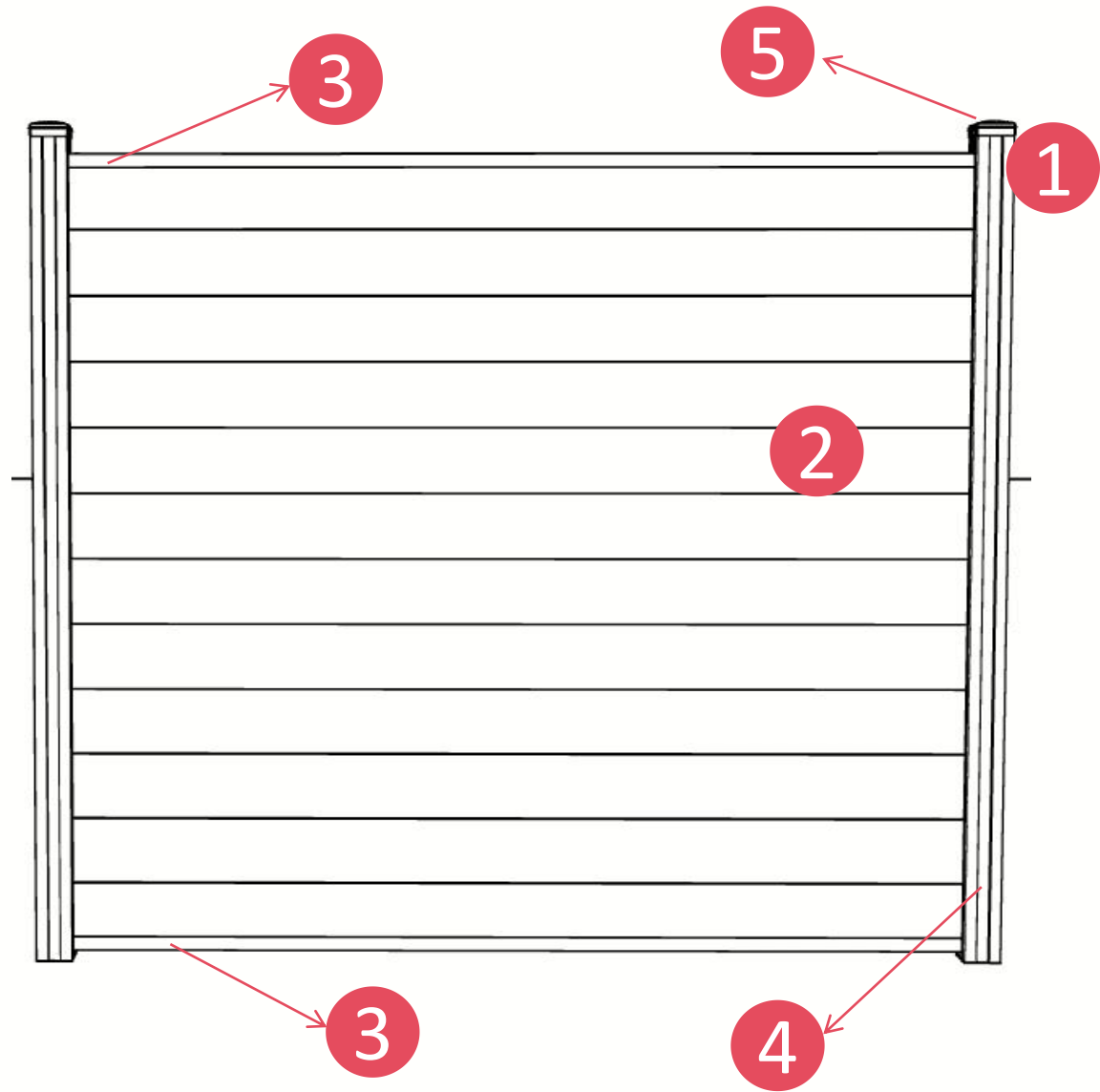
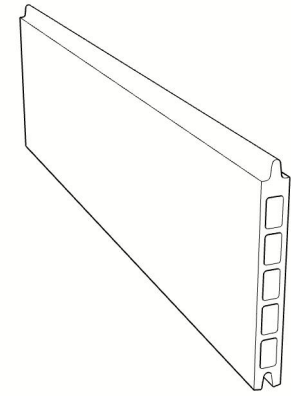

2 1.8m Fence Board

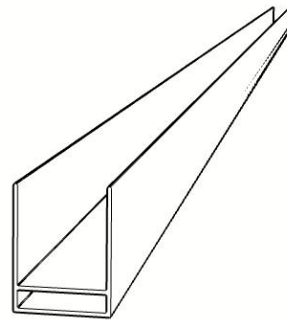

3 Top & Bottom Rail

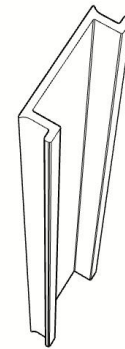

4 Aluminium Strip

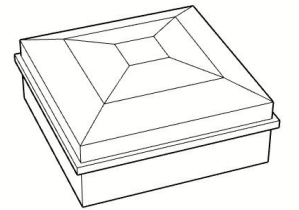

5 Plastic Cap

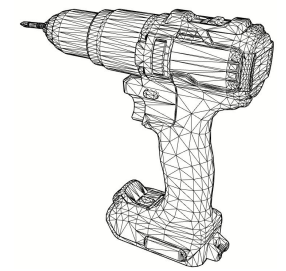
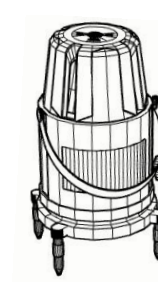
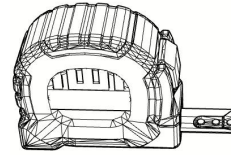
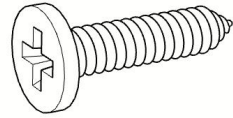
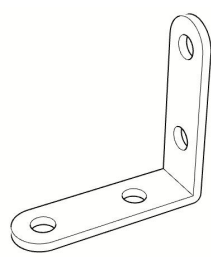
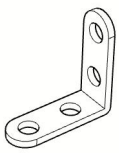

Small “L” Bracket

Big “L” Bracket

Screws

Tape Measure

Laser Level

Power Drill

Basic Requirements for Ground Installation

Ground Material

Preferred: Compacted soil, hardened concrete ground, gravel cushion ground

Prohibited: Soft backfill, silt, quicksand, and long-term waterlogged depressions (must be hardened or replaced first)

The overall slope and flatness of the ground should not be excessive. The column positions must be roughly level to prevent fence tilting caused by height differences.

Underground conditions shall be confirmed in advance to ensure no cables, water pipes, gas pipes, or optical cables are present, to avoid damage during drilling.

Bearing Capacity Requirement: The ground must withstand the dead weight of the columns and concrete, as well as lateral wind forces. Soft soil must be replaced with gravel and compacted.

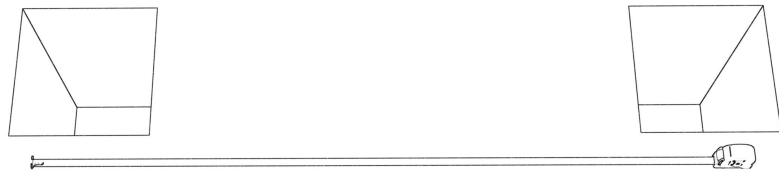

Setting Out & Positioning

Stretch a straight line according to the drawings to mark the position of each column.

Standard spacing: determined by the width of the fence panel .

Excavating Foundation Pits

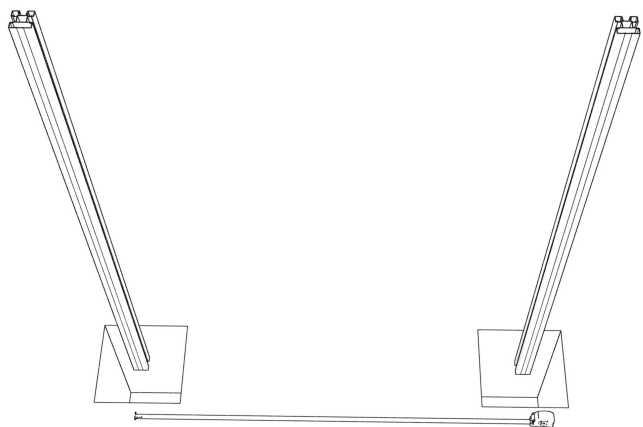

Pit dimensions:

Length × Width × Depth = 50 × 50 × 80 cm

Embedded depth of columns: 80 cm

Compact the pit bottom and lay a 5–10 cm gravel layer for drainage.

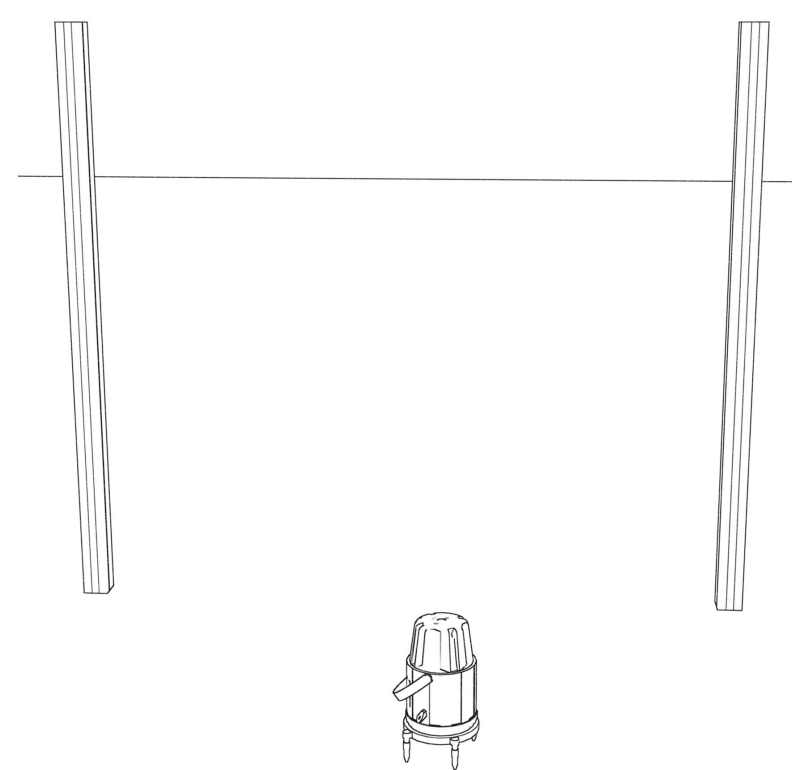
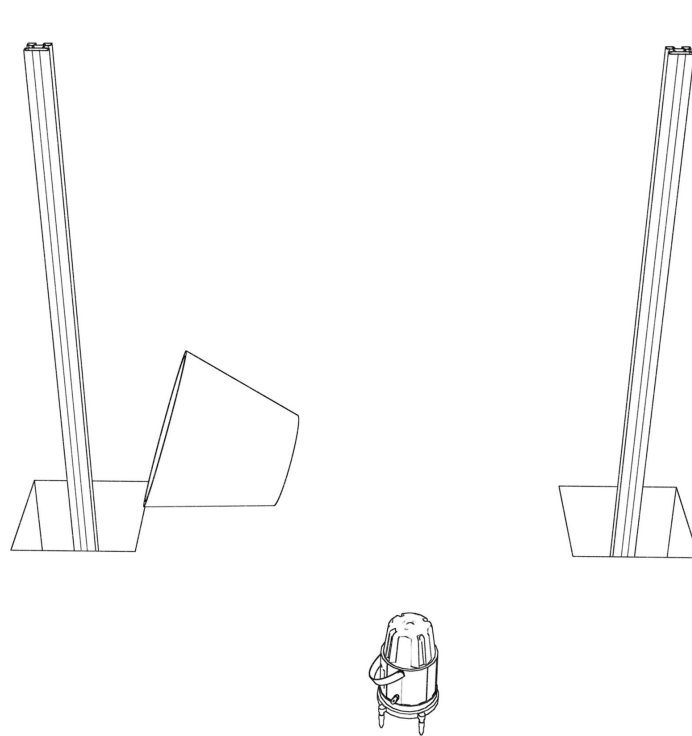
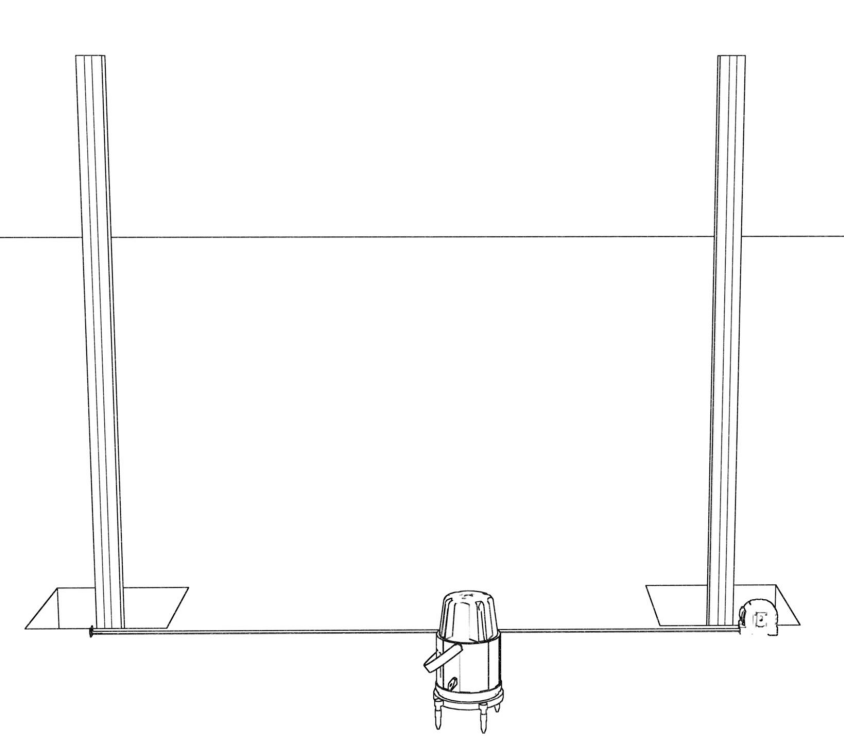

Placing the Post

Place the column vertically into the center of the pit. Use a laser level to check and correct verticality (measure on both sides).

Temporarily fix the column with timber battens or bricks to ensure it is not tilted or displaced.

Pouring Concrete

Mix ratio:
Cement : Sand : Gravel $\approx 1 : 2 : 3$

Pour in layers and tamp while pouring to avoid hollow voids.

The concrete surface shall be slightly higher than the ground level, with a gentle slope outward to prevent water accumulation and corrosion at the base.

Do not move or adjust the column before the concrete initial sets.

Fence mesh or fence panels may be installed after initial setting (approx. 2–4 hours).

The concrete must be cured for 24 hours before applying any load

Normal use is permitted after 48 hours.

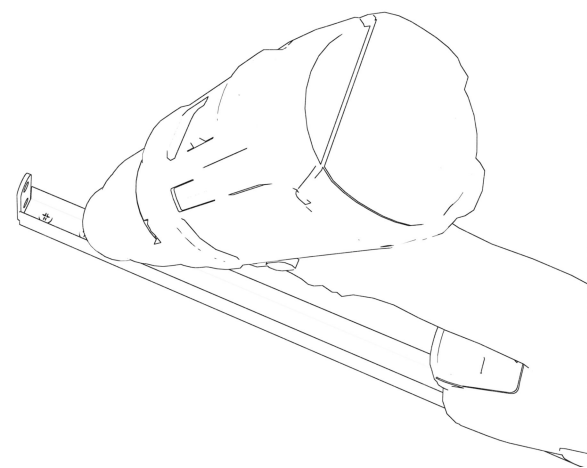
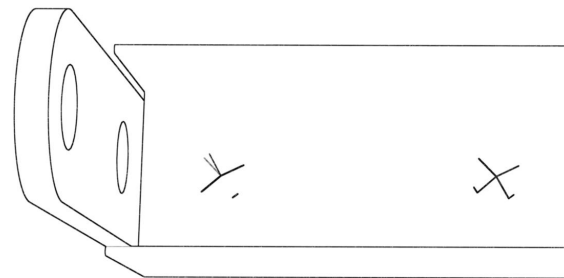
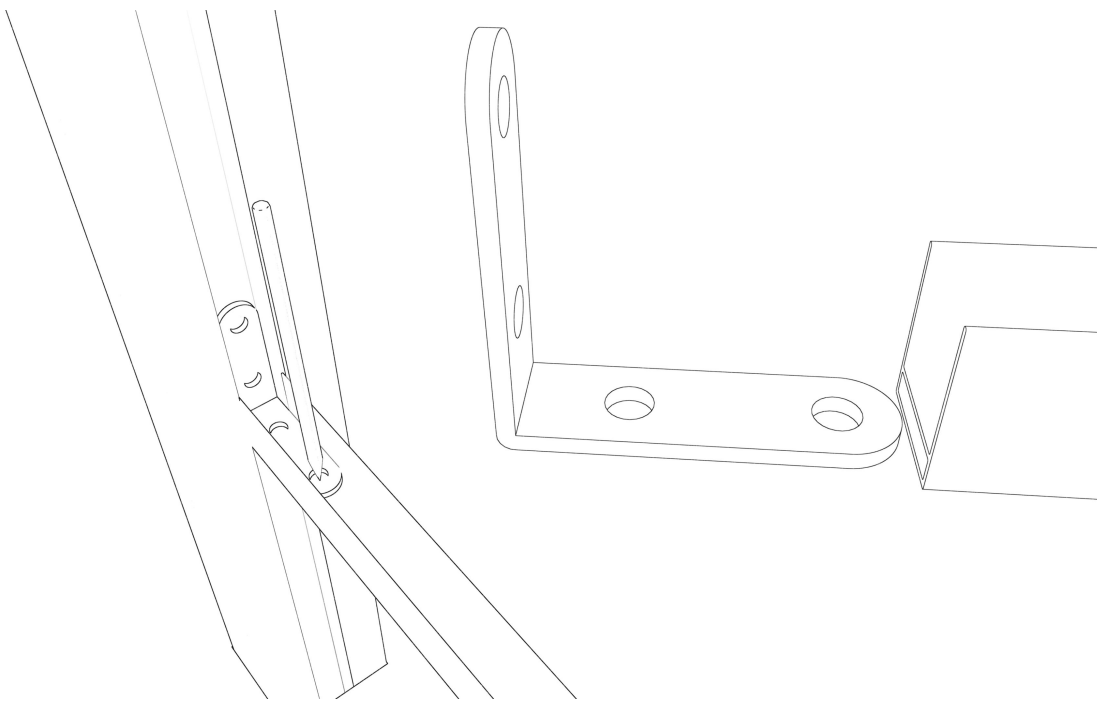

Bottom Rail Assembly

Insert the bottom rail into the post slot with the opening facing upward.

Place the big bracket into the bottom rail slot, with the other side pressing against the post slot.

Use a marker pen to mark the screw hole positions for installing the big bracket on the bottom rail.

Insert the big bracket into the slot of the bottom rail , and secure the big bracket to the bottom rail at the marked positions using self-drilling screws.

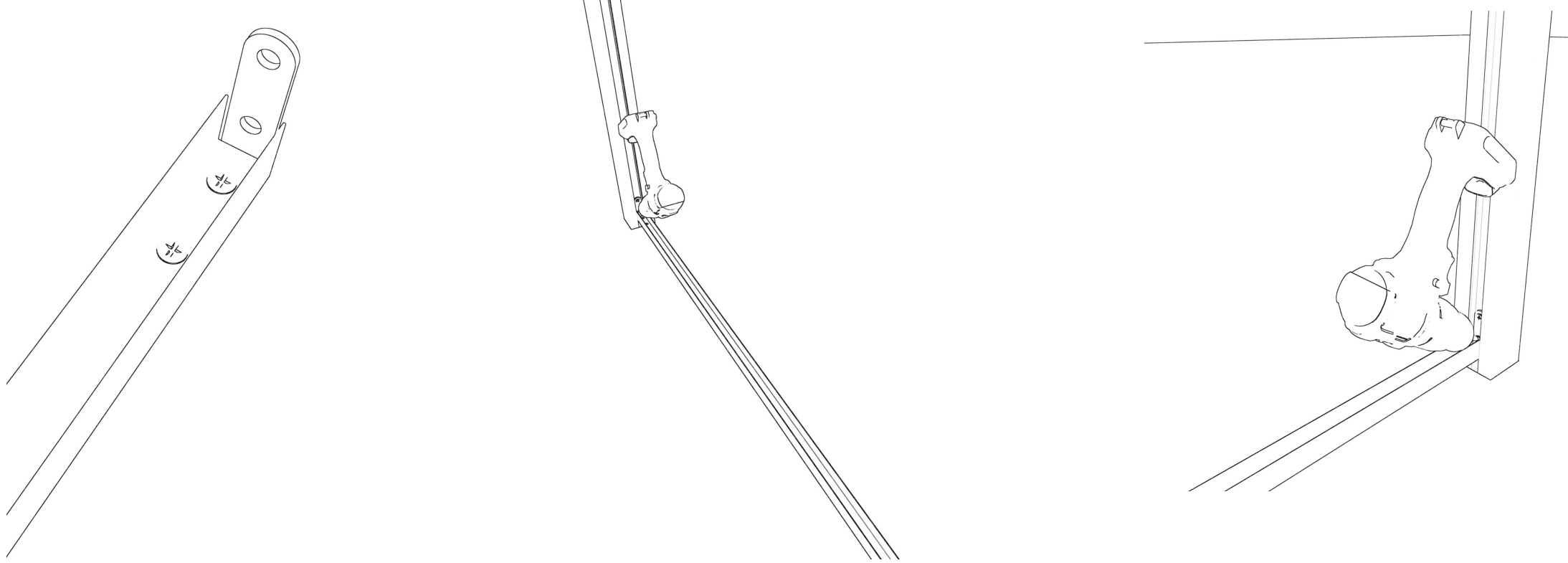

Assemble the big brackets on both sides of the bottom bracket. Use self-drilling screws to fasten the bottom bracket to the post slot through the vertical screw holes of the big brackets. Keep the bottom 2 cm above the ground (adjustable according to on-site ground conditions).

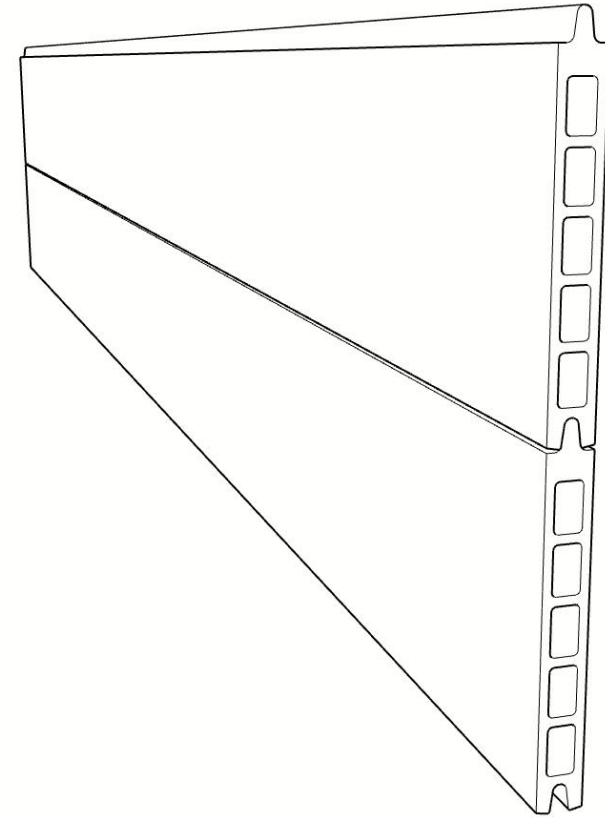
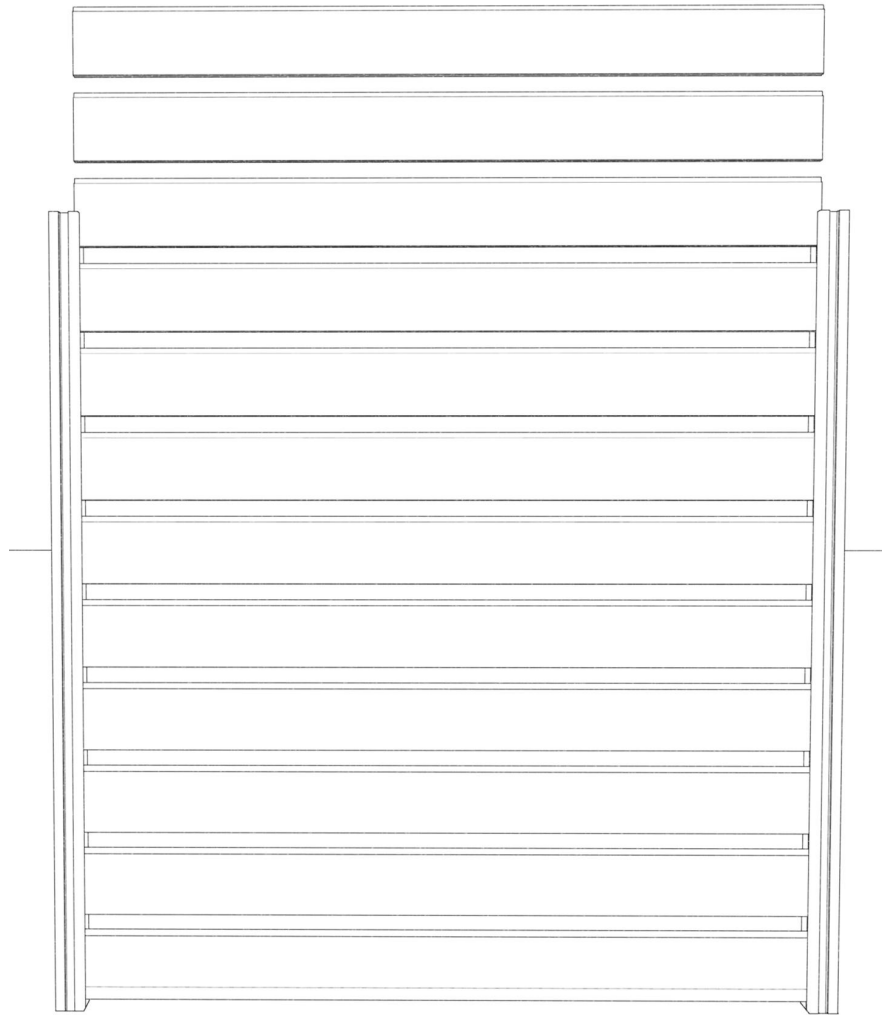

Install the fence panels with their raised edges facing upward, and mount them onto the bottom one by one.,

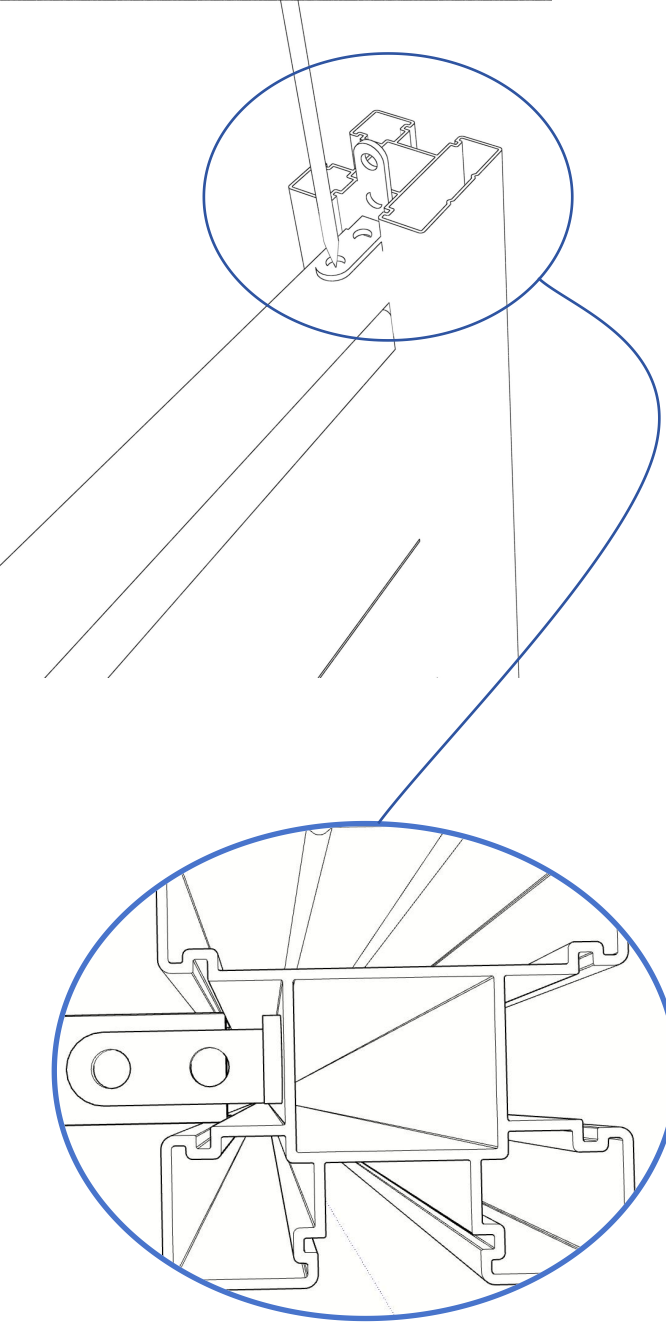

Using the same installation method as the Bottom bracket, assemble the top bracket with small brackets, with the opening of the top bracket facing downward.

Install the top bracket onto the fence panel, then use self-drilling screws to fix the top bracket into the post slot through the vertical screw holes of the small brackets.

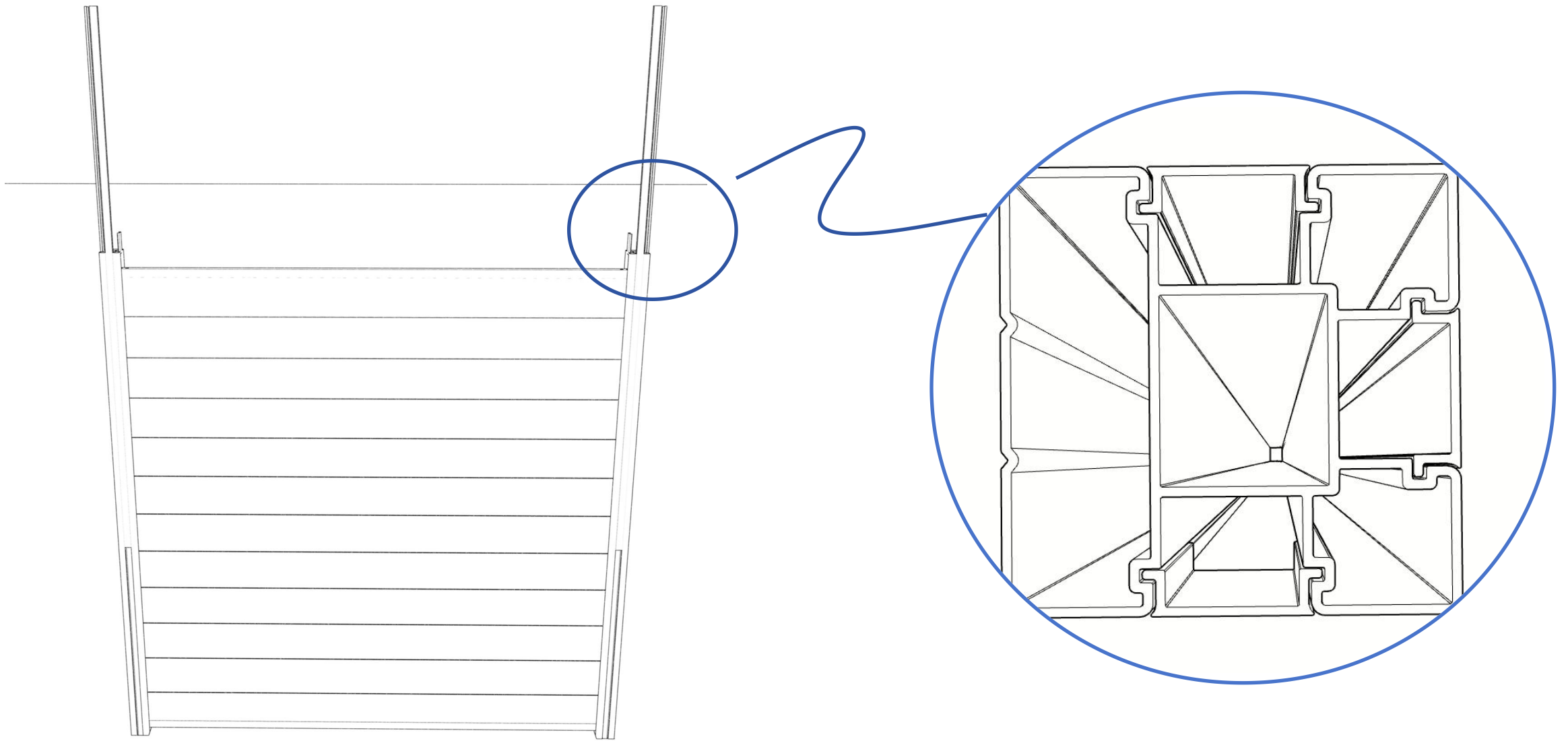

Install the strips into the unused post slots.

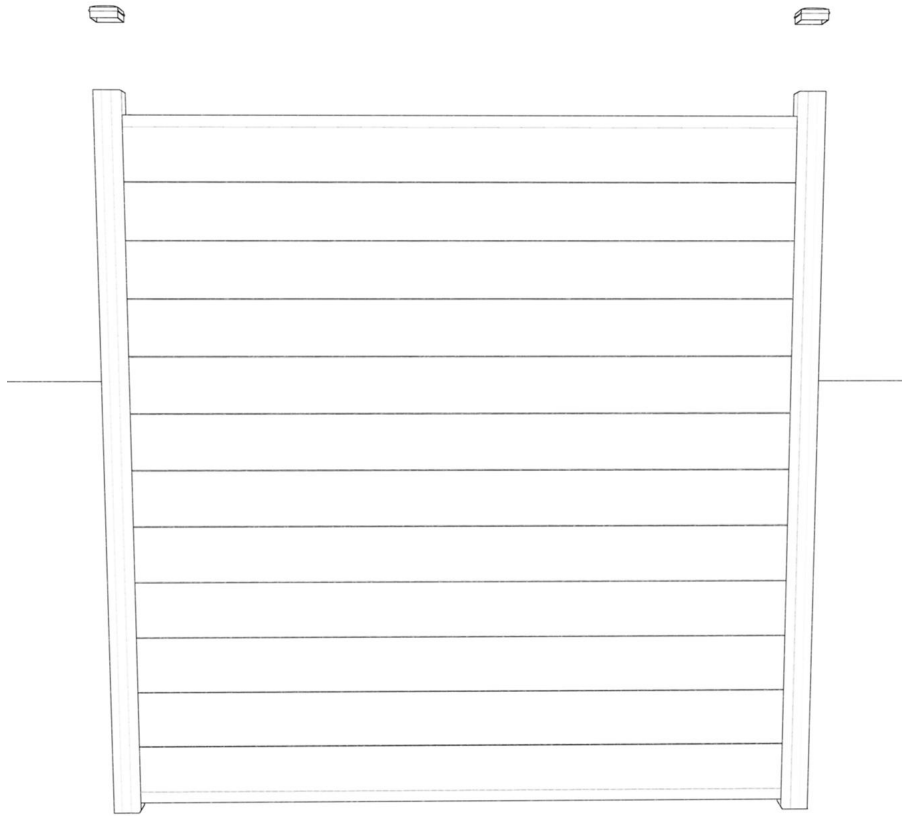

Install the post cap onto the post.

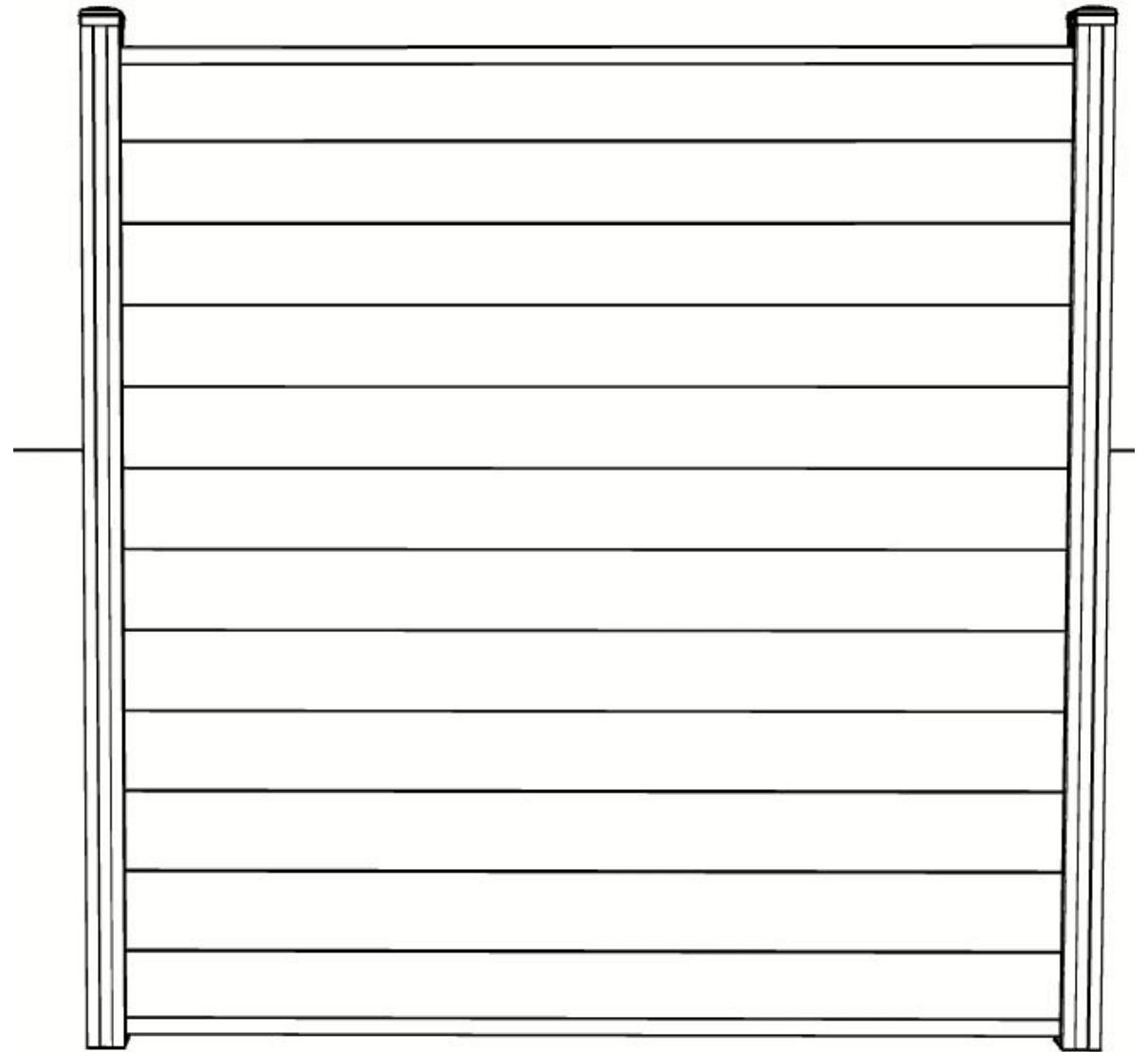

Installation Complete